

BALL MOUNT SERIES

Features

- All elastomer isolators
- Fail-safe when installed with ordinary nuts & washers
- Wide load range ratings
- Offer a wide variety of installation options

Benefits

- Provide low frequency vibration isolation
- Effective noise isolators
- Will not bottom out under light shock loadings

Load Range

- Series 7110 = 3 load ratings to 2 lbs. per isolator
- Series 275 = 5 load ratings to 3.2 lbs. per isolator
- Series 302 and 372 = 4 load ratings to 9 lbs. per isolator

Low cost, compact, all elastomer mounts for vibration and noise control.



Barry Ball Mount Series Isolators are miniature, low-cost isolators that provide medium natural frequency vibration isolation for precision equipment, electronics and office equipment.

Applications

- Electromechanical equipment
- Medical equipment
- Appliances
- Office equipment
- Other precision applications

NATURAL FREQUENCY	10-20 Hertz
TRANSMISSIBILITY AT RESONANCE	10 (Neoprene)/4.0 (Silicone)
RESILIENT ELEMENT	Neoprene or Hi-damp silicone
STANDARD MATERIALS	None
WEIGHT	See load range table

Environmental Data

- Neoprene elastomer has an operating temperature range of -40°F to +180°F (-40°C to +83°C) and is resistant to oil and ozone.
- Silicone elastomer has an operating temperature range of -67°F to +300°F (-55°C to +150°C).

Ball Mount Series (275/372)

Dimensions & Performance Characteristics

275 Series Dimensional Drawing

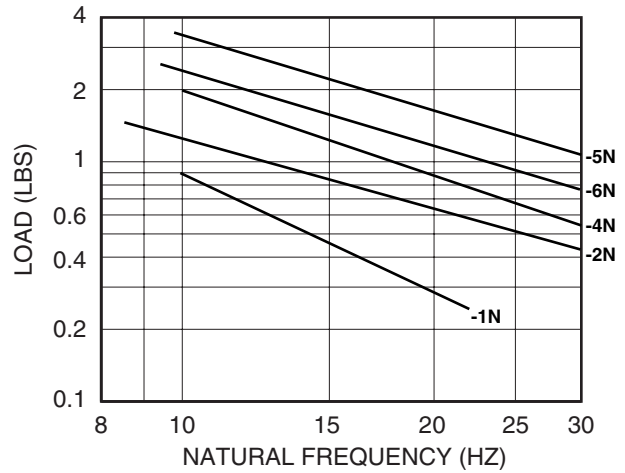
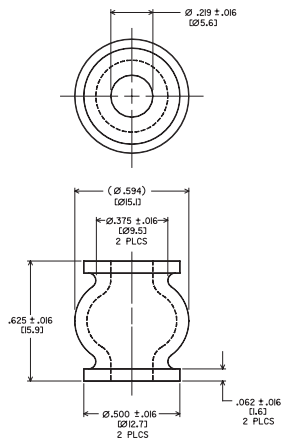

372 Series Dimensional Drawing

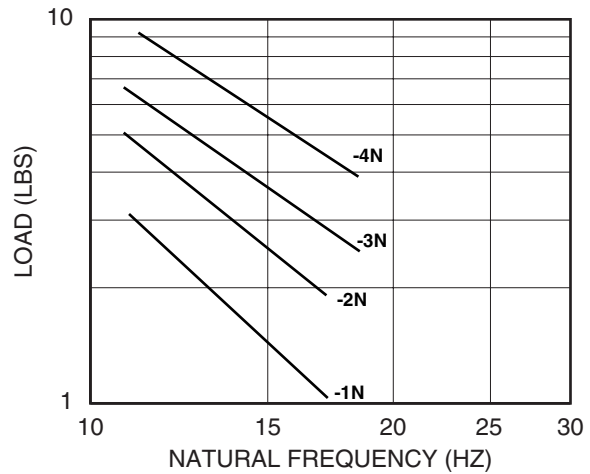
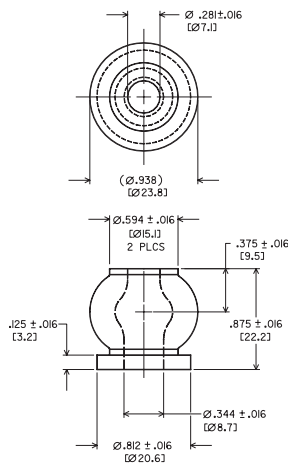

Barry Controls
40 Guest Street • Brighton, MA 02135-9105 • (617) 787-1555 • Fax (617) 787-7807

Dimensions and data are subject to change without notice.

For technical, design, or application assistance, call toll free:

1-800-BARRY MA

Ball Mount Series (302/7110)

Dimensions & Performance Characteristics

302 Series Dimensional Drawing

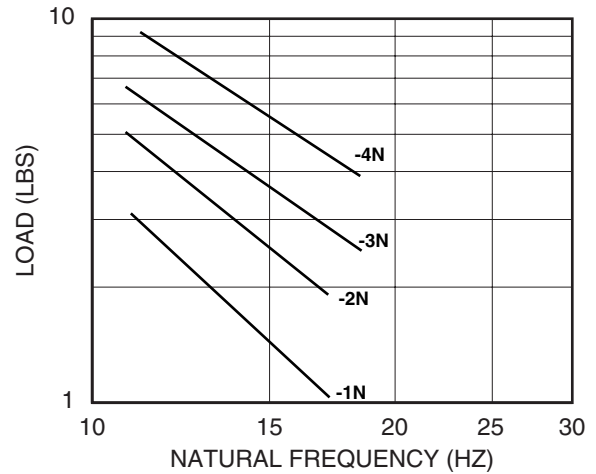
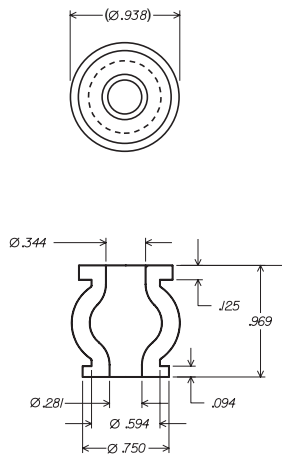

7110 Series Dimensional Drawing

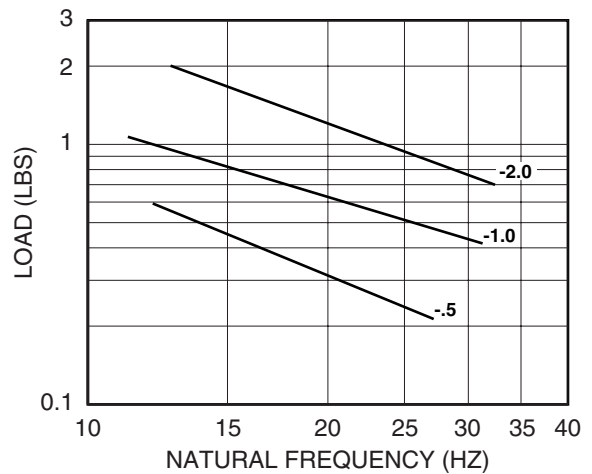
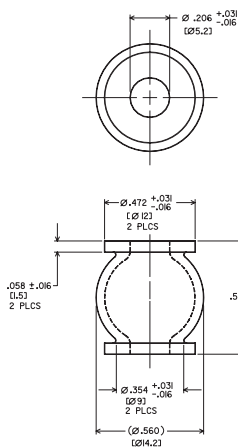

Barry Controls
40 Guest Street • Brighton, MA 02135-9105 • (617) 787-1555 • Fax (617) 787-7807

Dimensions and data are subject to change without notice.

For technical, design, or application assistance, call toll free:

1-800-BARRY MA

Ball Mount Series

Installation Data & Load Range Specifications

TYPICAL INSTALLATION - BALL MOUNT

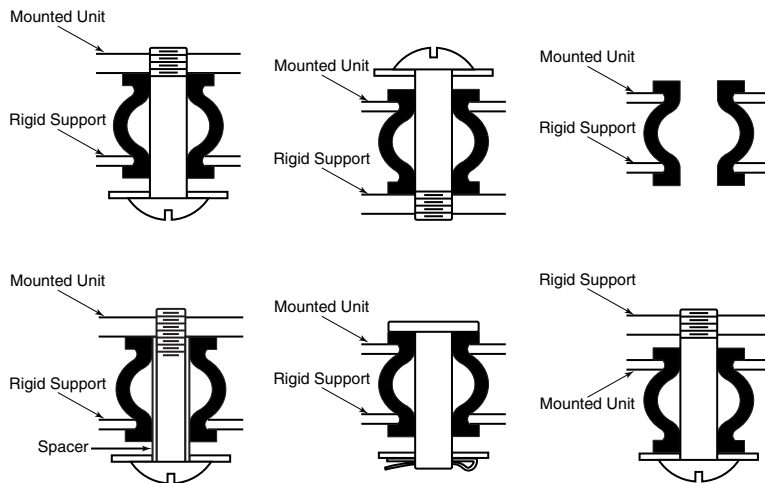

BALL MOUNT SERIES LOAD RANGES AND SPECIFICATIONS

Elastomer	Catalog No.	Color Code	Static Load Range/ Mount (lbs)	Horiz. to Vert. Stiffness Ratio	Wt. (ozs.) Approx.
Neoprene	275-1N	Orange & White	0.4-0.7	0.35 (Approx.)	0.1
	275-2N	Red & White	0.6-1.2		
	275-4N	Yellow & White	0.8-1.6		
	275-5N	Green & White	1.3-2.6		
	275-6N	Blue & White	1.6-3.2		
Neoprene	302-1N 372-1N	Yellow & White	1.3-3.5	0.25 (Approx.)	0.5
Neoprene	302-2N 372-2N	Purple & White	2.3-4.5		
Neoprene	302-3N 372-3N	Green & White	3.0-6.0		
Neoprene	302-4N 372-4N	Blue & White	4.5-9.0		
Silicone	7110-0.5	Red	0.3-0.5	0.35	0.1
	7110-1.0	Blue	0.5-1.0	0.35	0.1
	7110-2.0	Orange	1.0-2.0	0.35	0.1



Barry Controls
40 Guest Street • Brighton, MA 02135-9105 • (617) 787-1555 • Fax (617) 787-7807

Dimensions and data are subject to change without notice.

For technical, design, or application assistance, call toll free:

1-800-BARRY MA